











## Monteringsvejledning

MODEL : SCANDIC BALDER 5,5 ALUMINIUM SOKKEL  
LÆS HELE VEJLEDNINGEN FØR MONTAGE

DEL	NR.	STK	DEL	NR	STK
 1650.8mm	DJ03	2	 Ø5X40	Z13	4
	D74	2	 M6X10	S14	8
	D121	4	 M6	M03	12
 Ø6.5XØ16x1.2	H79	4	 TSM6X14	S16	4

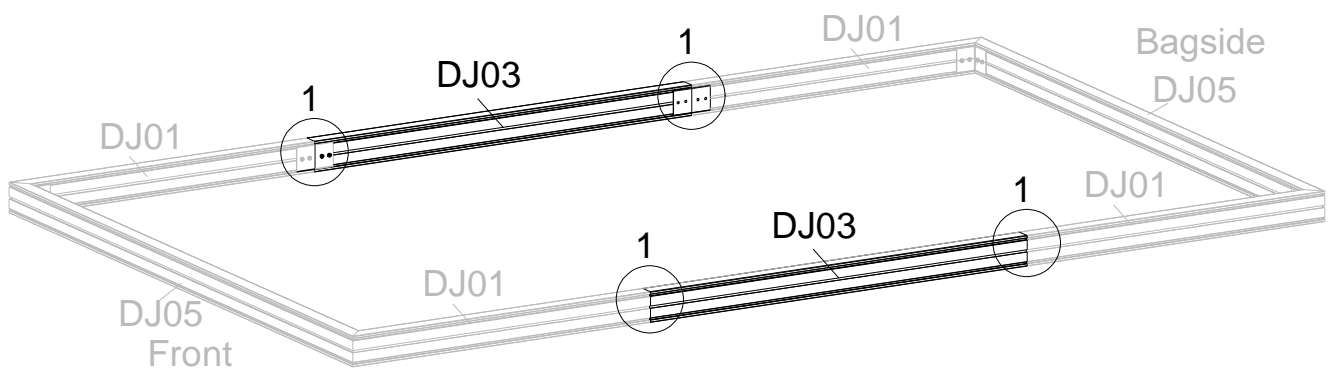

Saml DJ03 med DJ01 med beslag D74,  
brug S14 & M03.

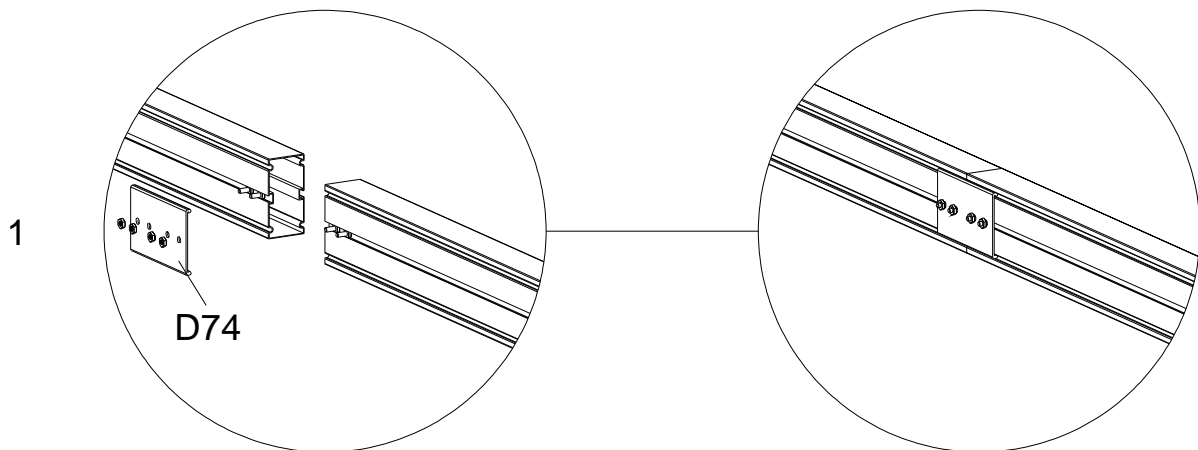

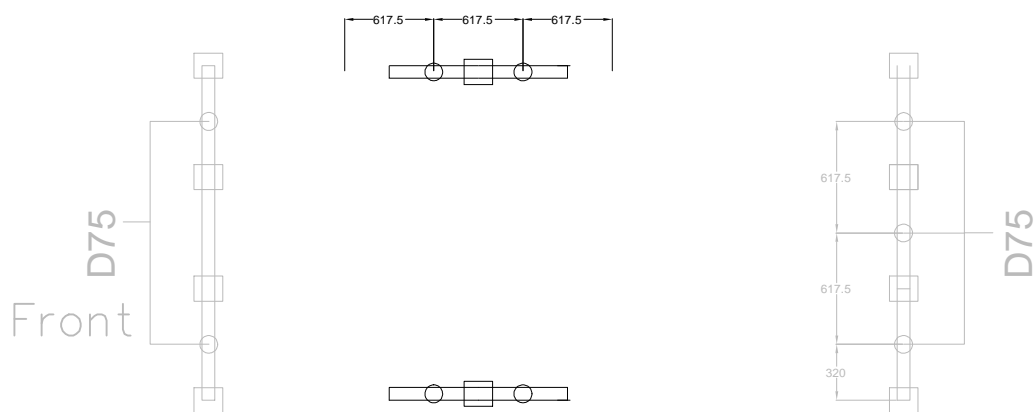

## Balder 5,5 Udbygning

Placer først hele soklen, saml med vinkel- og ankerbeslag. Skru det hele sammen med medfølgende bolte og møtrikker. Få ankerbeslagene hæftet i fliser/beton/træ, men lad være at spænde dem helt ned, før huset er samlet færdigt.

Denne skitse viser D121 placering, midt ud for hvert glas.

